

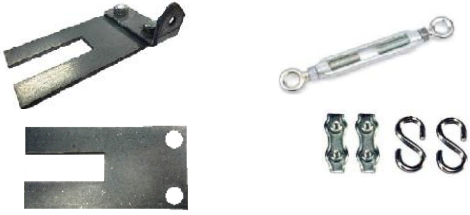

MATERIELS NECESSAIRES

<p>Kit de synchronisation 1 tendeur / 2 eses / 2 serres câbles + Guide câble et cale (Vantaux inégaux seulement)</p>	8	<p style="text-align: center;">Équerre fixation câble)</p>	9	<p style="text-align: center;">Cale</p>
				

VANTAUX EGAUX

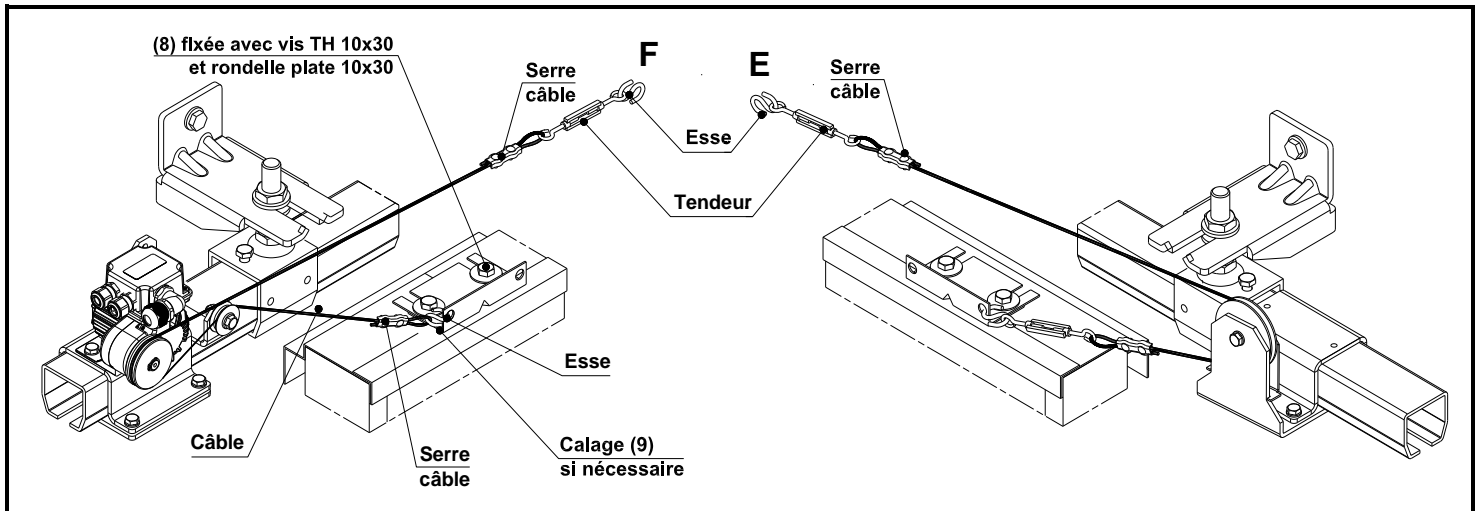
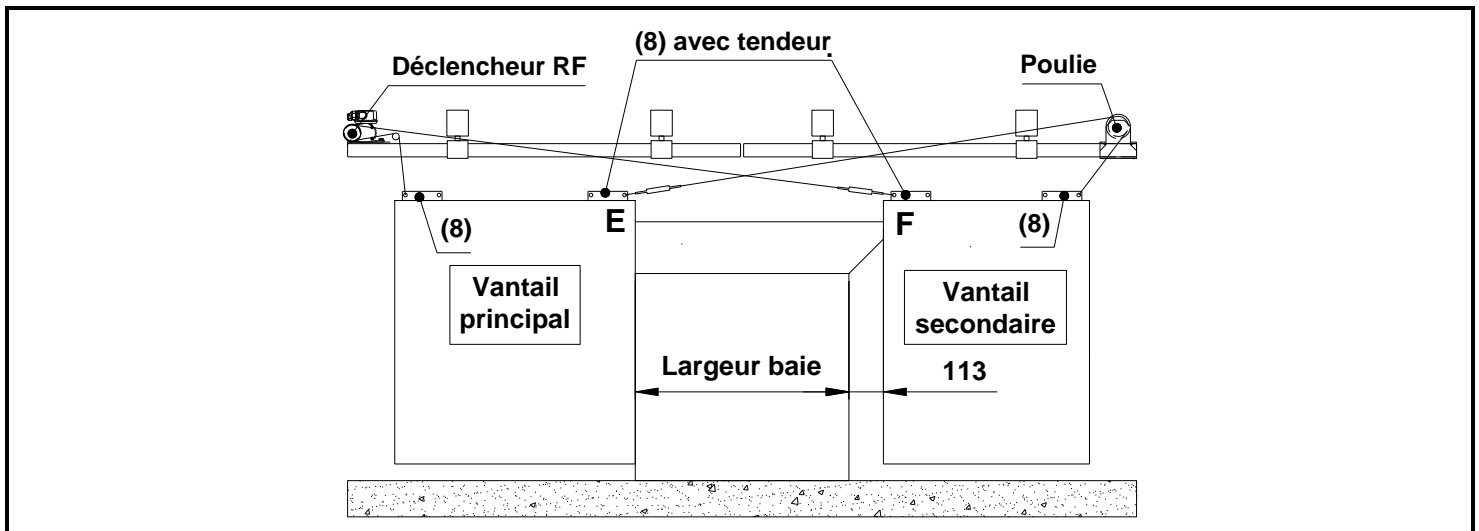

VANTAUX INEGAUX

Vantaux ouverts

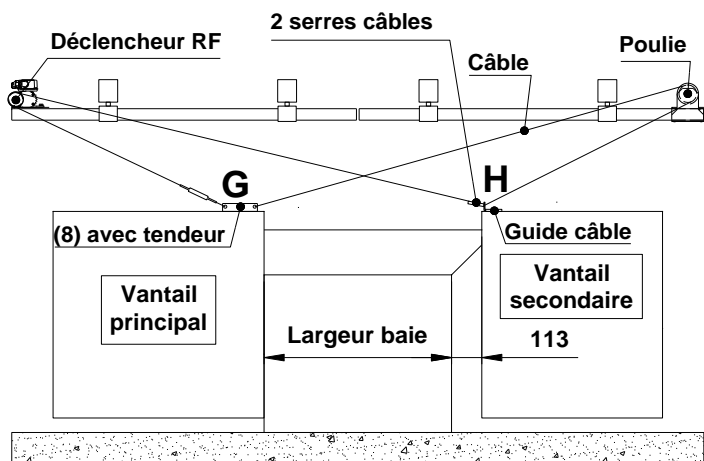

Vantaux fermés

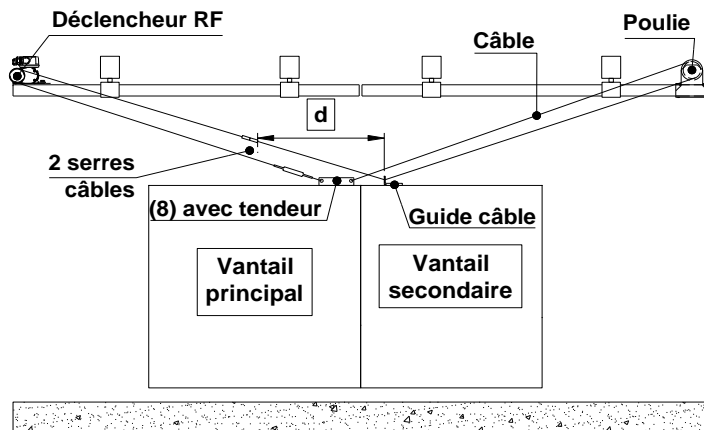

Calcul de la côte d

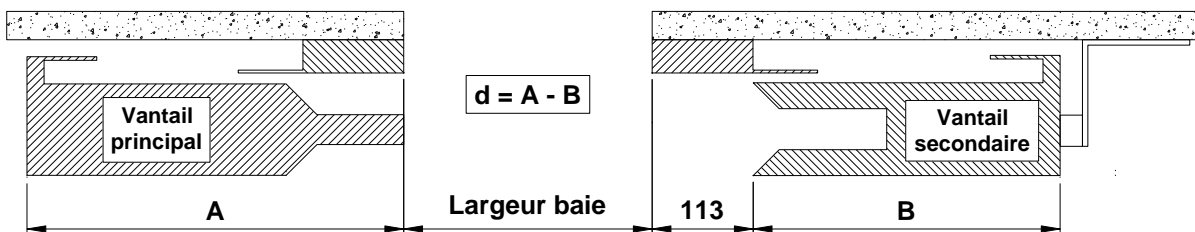

Câblage du vantail principal

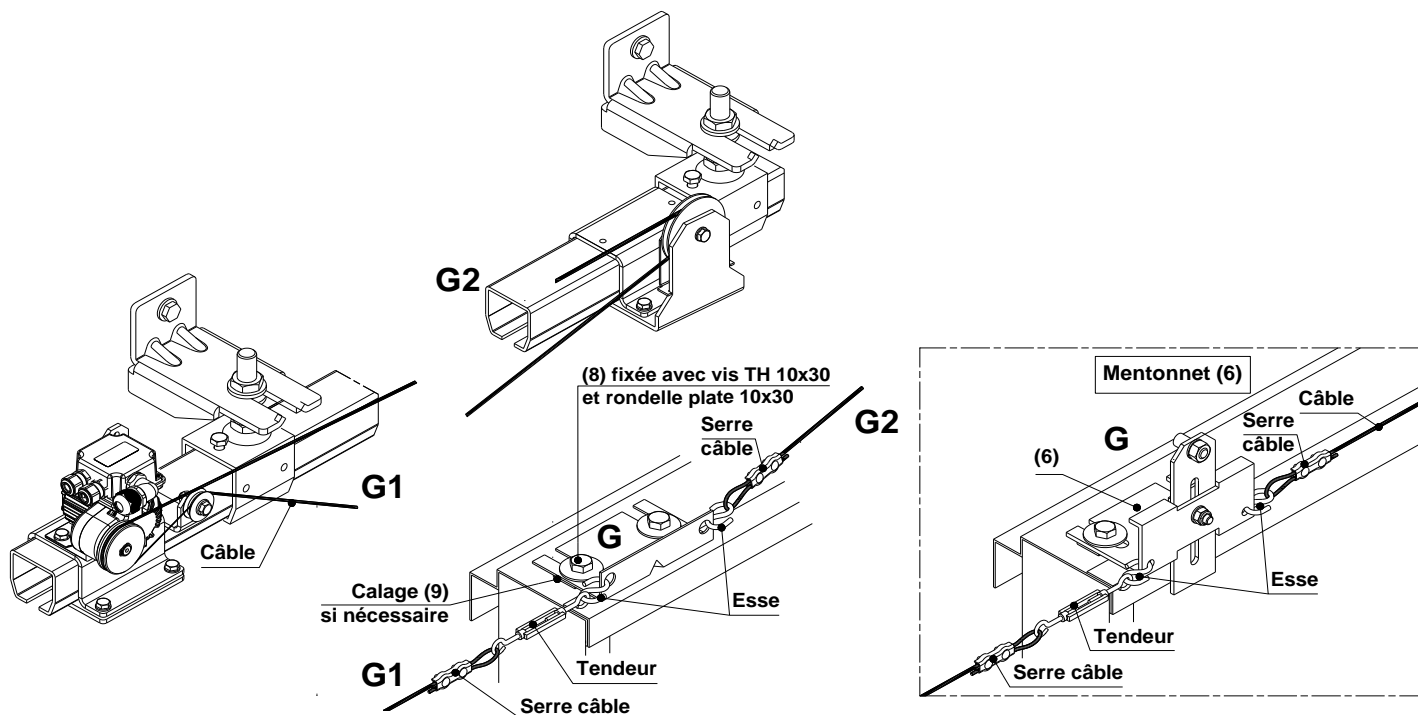

Câblage du vantail secondaire

